

637/638 SERIES



D-Sub Connectors: Vertical, High Density

Features:

- Plug and receptacle in 15, 26, 44, 62 or 78 contact sizes
- Pin and socket contact mating design with P.C. tail termination
- Metal shell provides EMI/RFI shielding, plug shell indents provide grounding and additional mating retention
- Grounding features include boardlock for exceptional retention to P.C. board
- Mounting options for panel mount or connector mating include through hole, threaded hole and threaded standoffs
- D-shaped connector mating outline provides polarization
- Design based on requirements of MIL-C-24038, EIA RS-232 and RS-449
- High profile available in receptacle only



Specifications:

Insulator Material	PBT with glass fiber, UL 94V-0, color: Black
Contact Material	Plug (pin): Brass Receptacle (socket): Brass or phosphor bronze
Contact Plating	Selective gold (see ordering code) over nickel for the mating area, tin plating for tail area
Shell Material	Nickel plated steel (optional tin plating)
Current Rating	3 amps
Contact Resistance	15 milliohms maximum
Insulation Resistance	1000 megaohms minimum
Dielectric Withstanding Voltage	500 V AC rms at Sea Level
Operating Temperature	-55°C To +85°C (upto +125°C for high temp)
Insertion Force	16 oz (4.45 N) Maximum Per Contact Position
Withdrawal Force	1 oz (0.28 N) Minimum Per Contact Position

Ordering Code:

637-015-230-047

SERIES: _____
 637: PLUG (PIN)
 638: RECEPTACLE (SOCKET)

NO. OF CONTACTS: _____
 015 - 15 CONTACTS 026 - 26 CONTACTS
 044 - 44 CONTACTS 062 - 62 CONTACTS
 078 - 78 CONTACTS

CONTACT FINISH CODE: _____
 2 - GOLD FLASH PLATING
 3 - 15µ" OF GOLD PLATING
 6 - 30µ" OF GOLD PLATING

TERMINATION: _____
 010 - CRIMP AND LOAD (CABLE ASSEMBLY)

CONTACT CODE: _____
 30 - PCB TAIL STANDARD PROFILE INSULATOR
 31 - PCB TAIL HIGH PROFILE INSULATOR
 32 - SOLDER CUP (STANDARD PROFILE ONLY)

FLANGE MOUNTING OPTIONS:
 1 - DIA. .120" (DIA. 3.05MM) THROUGH HOLE
 2 - #4-40 THREADED CLUNCH NUT (BOARDSIDE) .098" (2.49mm)
 3 - #4-40 THREADED STANDOFF
 6 - #4-40 THREADED HOLE WITH BOARDLOCKS (N/A FOR CRIMP & LOAD TERMINATION)
 7 - #4-40 THREADED STANDOFF WITH BOARDLOCKS (N/A FOR CRIMP & LOAD TERMINATION)
 8 - #4-40 THREADED CLINCH NUT (MATING SIDE) .236" (6.00mm)
 9 - #4-40 THREADED CLINCH NUT (BOARDSIDE) .236" (6.00mm)

INSULATOR STYLE:
 4 - STANDARD PROFILE - STANDARD TEMP (N/A FOR CRIMP & LOAD TERMINATION)
 5 - HIGH PROFILE - STANDARD TEMP (RECEPTACLE AND CRIMP & LOAD ONLY)
 6 - STANDARD PROFILE - HIGH TEMP (N/A FOR CRIMP & LOAD TERMINATION)
 7 - HIGH PROFILE - HIGH TEMP (RECEPTACLE ONLY) (N/A FOR CRIMP & LOAD TERMINATION)

SHELL PLATING
 0- NICKEL PLATED SHELL
 2- TIN PLATED SHELL

Contact P/N:	"Wire Gauge (AWG):
638-292-271	24 - 26

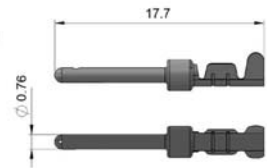

Contact P/N:	Wire Gauge (AWG):
637-292-271	24 - 26

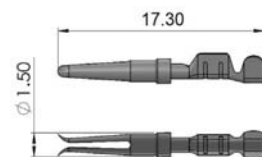

637/638 SERIES



D-Sub Connectors: Vertical, High Density

STANDARD PROFILE

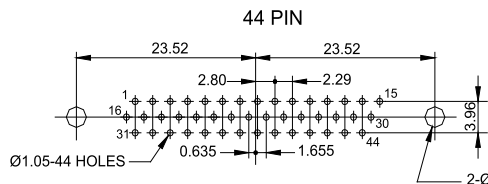
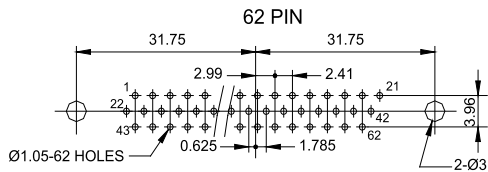
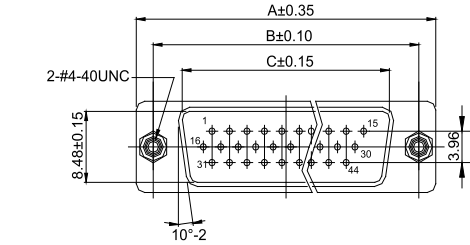

PLUG 637 SERIES

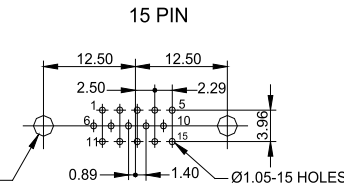
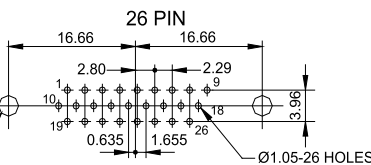
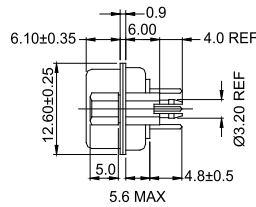

CRIMP TYPE

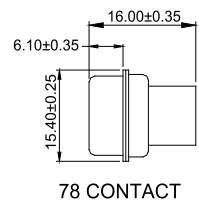
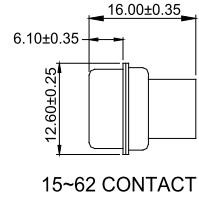

STANDARD PROFILE

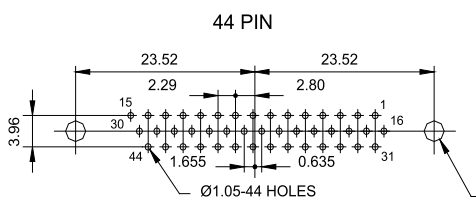
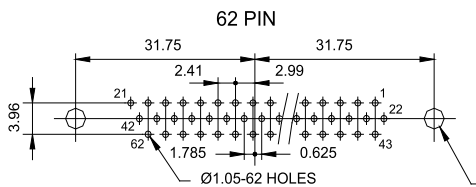
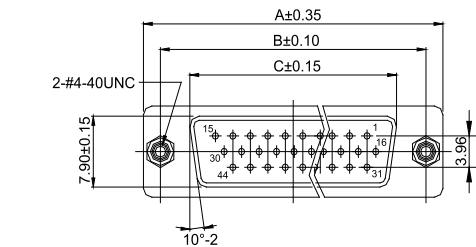

RECEPTACLE 638 SERIES

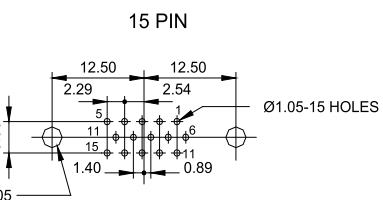
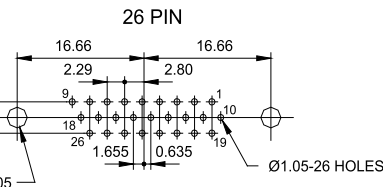
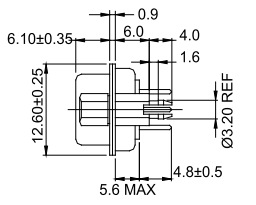

CRIMP TYPE

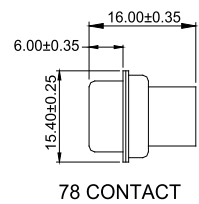
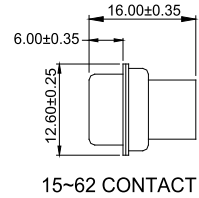

NUMBER OF CONTACTS	A		B		C PLUG		C RECEPTACLE	
	Inch	(mm)	Inch	(mm)	Inch	(mm)	Inch	(mm)
15	1.213	(30.80)	.984	(24.99)	.666	(16.92)	.642	(16.30)
26	1.541	(39.15)	1.312	(33.32)	.994	(25.25)	.970	(24.65)
44	2.087	(53.00)	1.852	(47.04)	1.534	(38.96)	1.512	(38.40)
62	2.728	(69.30)	2.500	(63.50)	2.182	(55.42)	2.157	(54.80)

637/638 SERIES



D-Sub Connectors: Vertical, High Density

78 PIN STANDARD PROFILE

PLUG 637 SERIES

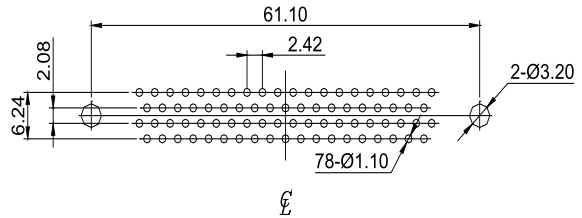
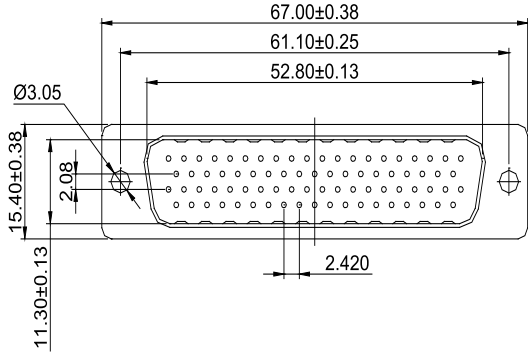

RECOMMENDED PCB LAYOUT

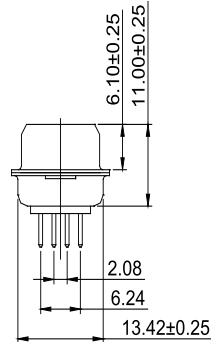
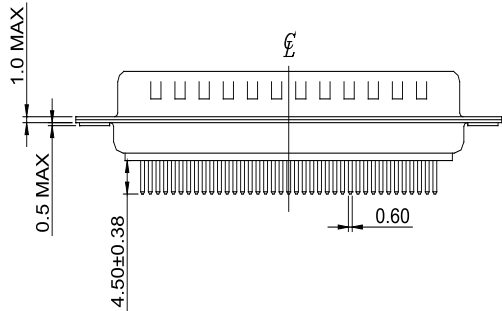

RECEPTACLE 638 SERIES

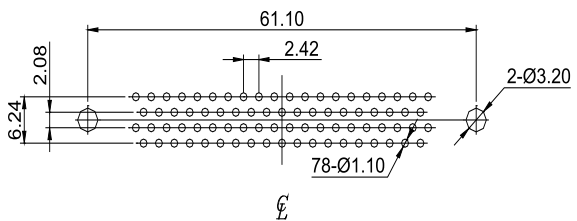
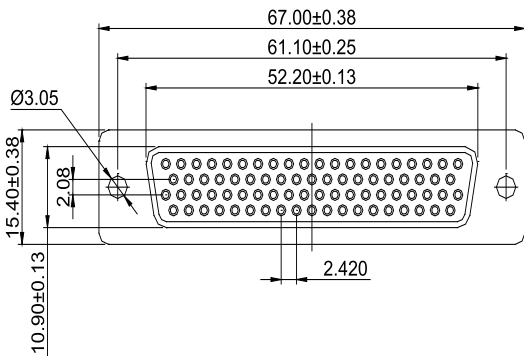

RECOMMENDED PCB LAYOUT

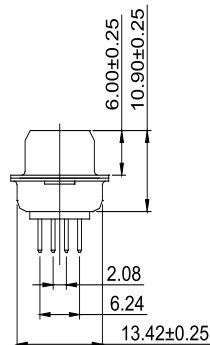
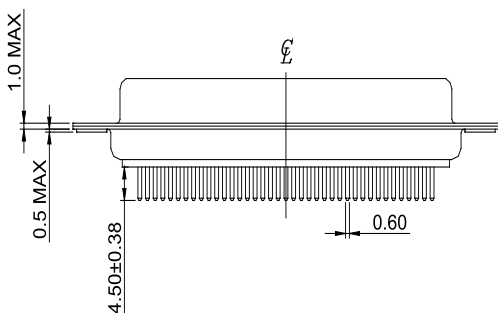

637/638 SERIES



D-Sub Connectors: Vertical, High Density

RECEPTACLE 638 SERIES

HIGH PROFILE

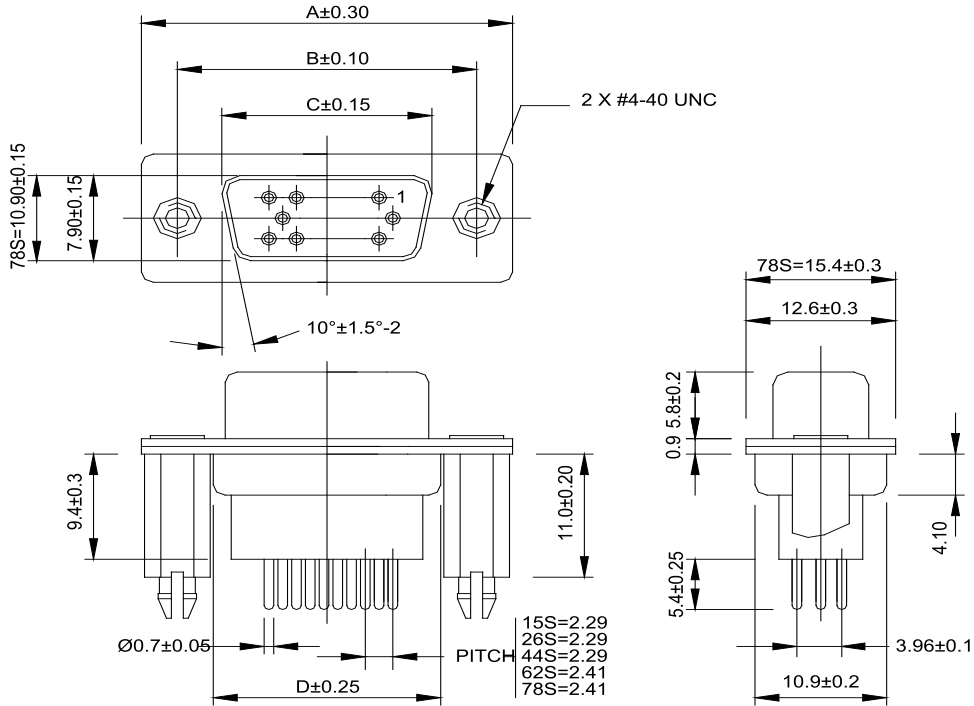

NUMBER OF CONTACTS	A		B		C		D	
	Inch	(mm)	Inch	(mm)	Inch	(mm)	Inch	(mm)
15	1.213	(30.80)	.984	(24.99)	.643	(16.34)	.756	(19.20)
26	1.543	(39.20)	1.312	(33.32)	.972	(24.70)	1.091	(27.70)
44	2.087	(53.00)	1.852	(47.04)	1.512	(38.40)	1.618	(41.10)
62	2.732	(69.40)	2.500	(63.50)	2.157	(54.80)	2.256	(57.30)
78	2.638	(67.00)	2.406	(61.10)	2.055	(52.20)	2.169	(55.10)

FLANGE MOUNTING OPTIONS

